

# Industrial Series Auto-90 Sectionizer

One Product will Wedge, Slice and Halve



Versatile, Space-Saving, Cost Effective



Conveyor

- Automated Version of our Tabletop Sectionizer
- Can Sectionize up to 90 Pieces of Fruit per Minute
- Uniform Pieces for Appealing Presentation
- Automatic Sensor-Controlled Safety-Off System
- Auto-90 Sectionizer Comes With One Blade Set of Your Choice
  - Optional; 8 Different Interchangeable Blade Sets
- Quick & Easy Cleanup - Simply Hose Down with Water or Steam & Place Blade Cups/Plungers into Dishwasher for Sanitizing
- Warranty; Free From Defects of Workmanship & Materials Under Normal Use & Service for 1-Year
- Dimensions; 35"W x 52"L x 77"H
- Electrical; 250 AC, Single Phase, 20 amps

## Available from your Foodservice Equipment Dealer

Contact us for the one nearest you:

800.383.7141 Fax 909.822.2125 [www.sunkists.com/equipment](http://www.sunkists.com/equipment)

Foodservice Equipment Sales

Sunkist Growers

10730 Bell Court, Rancho Cucamonga, CA 91730



Proudly Made in the USA



# Industrial Series Auto-90 Sectionizer

One Product will Wedge, Slice and Halve

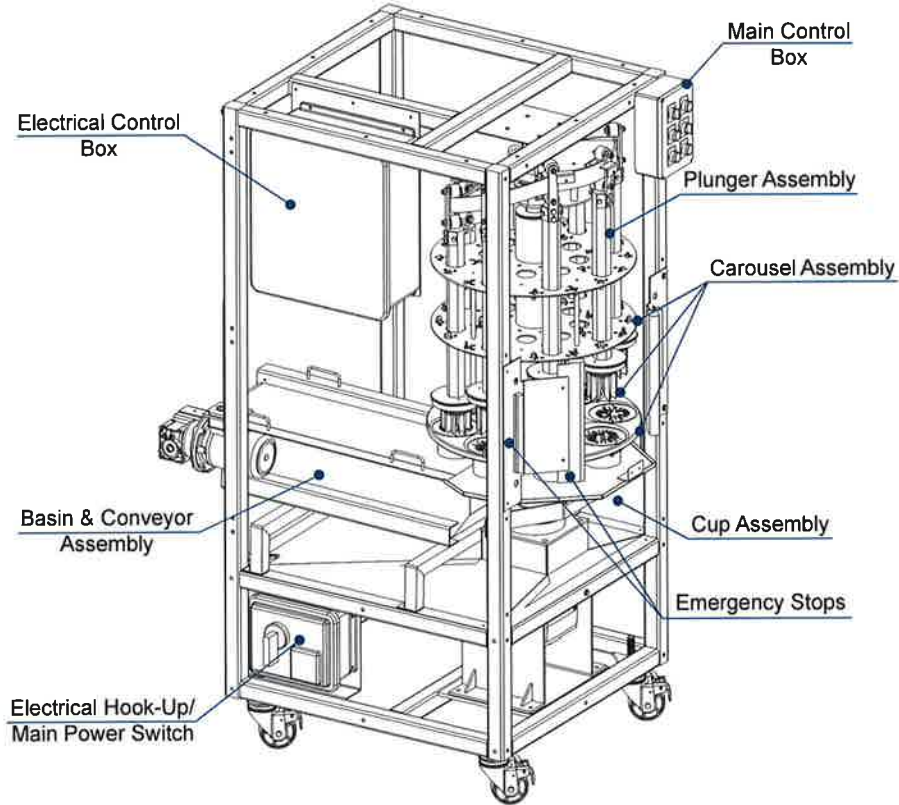

### Common Plungers



Apple

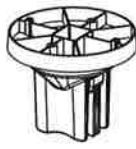

Slicing



1/2 Thru 8 Wedge



10 Wedge

### Blade Sets

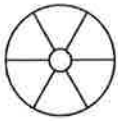

Apple Corer  
6-Wedge

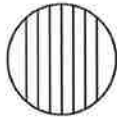

6-Slice

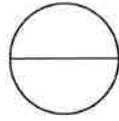

1/2 Cut

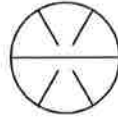

3-in-1

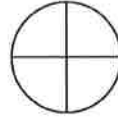

4-Wedge

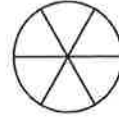

6-Wedge

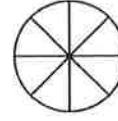

8-Wedge

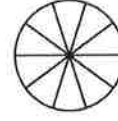

10-Wedge

Sunkist® foodservice equipment is recognized worldwide as a leading, innovative manufacturer of quality built commercial grade citrus juicers and fruit/vegetable sectionizers. When only the best will do!