

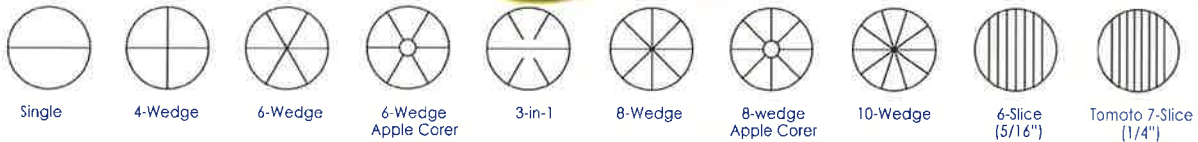



Quality products. Built to last.

commercial series sectionizer

10 matching blade and plunger sets



- ✓ Versatile, 10 different Interchangeable blade cups available
- ✓ Uniform pieces for appealing presentation
- ✓ Quick & easy cleanup – dishwasher safe
- ✓ Crafted in the USA  

SUNKIST
 Tel:800.383.7141 Fax:909.822.2125
 10730 Bell Court
 Rancho Cucamonga, CA 91730
www.sunkistequipment.com

Commercial Series Sectionizer Information





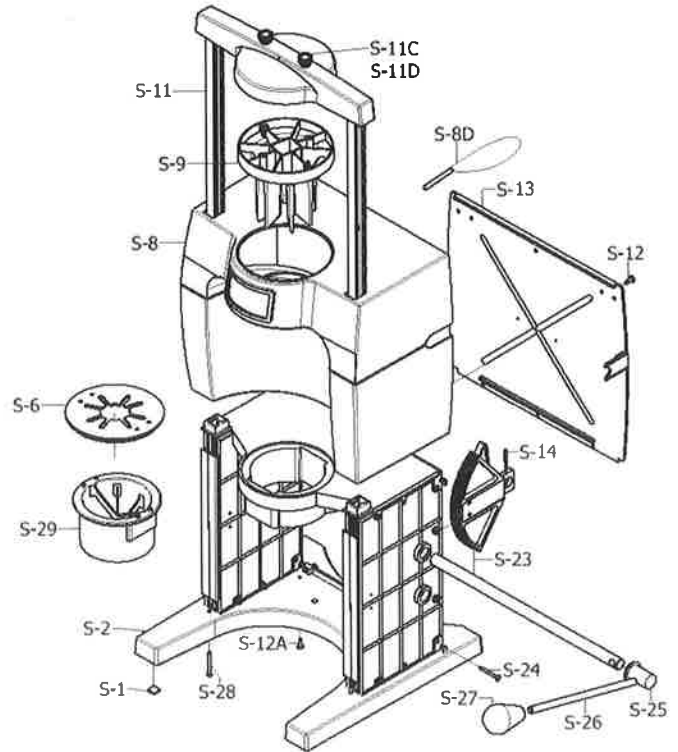





Effective: November 1, 2017

Part #	Description
S-1	Food Pad (set of 6)
S-2	Base Assembly
S-3B	Blade Cup w/cover (6 wedge) (fits S-9)
S-4B	Blade Cup w/cover (6 slice) (fits S-10)
S-5B	Blade Cup w/cover (4 wedge) (fits S-9)
S-6	Wedge Cup cover (sold w/S-3, S-5, S-29, S-30, S-32, S-35)
S-7	Slicer Cup cover (sold w/S-4)
S-8	Outer Shell
S-8D	Pin & Thread Assembly
S-9	Plunger Wedger (fits parts S-3, S-5, S-29, S-30, S-35)
S-10	Plunger Slicer (fits S-4)
S-11	Crossbar Assembly
S-11C	Brass Knob
S-11D	Brass Stud
S-12	Back Screw #8 x 1/2" (set of 8)
S-13	Back Cover
S-14	Spring Pin (set of 2)
S-15	Blade Cup w/cover (7 Slice Tomato) (fits S-16)
S-16	Plunger (7 Slice Tomato) (fits S-15)
S-17	7 Slice Tomato Set (S-15 & S-16)
S-19	Wedge Cup Cover (10 Wedge) (sold w/S-20)
S-20B	Blade Cup w/cover (10 Wedge) (fits S-21)
S-21	Plunger (10 Wedge) (fits S-20)
S-22	10 Wedge Set (S-20 & S-21)
S-23	Gears & Shaft Set
S-24	Base Side Screw 6/32 x 1 1/2" (set of 10)
S-25	Plastic Shaft Cover
S-26	Handle
S-27	Knob
S-28	Bottom Screw #8 x 1 1/2" (set of 4)
S-29B	Blade Cup w/cover (8 Wedge) (fits S-9)
S-30B	Blade Cup w/cover (3-in-1) (fits S-9)
S-31	Plastic Production Stand
S-32B	Blade Cup w/cover (Apple Corer-6 Wedge) (fits S-33)
S-33	Plunger (Apple 6-Wedge & 8-Wedge) (fits S-32)
S-34	Apple Corer-6 Wedge Set (S-32 & S-33)
S-35	Blade Cup w/cover (Single) (fits S-9)
S-37B	Blade Cup w/cover (Apple Corer-8 Wedge) (fits S-33)
S-33	Plunger (Apple 6-Wedge & 8-Wedge) (fits S-37B)
S-38K	Apple Corer-8 Wedge Set (S-37B & S-33)



Specifications

-Listed by	NSF International
-Shipping weight	15 pounds
-Net weight	13 pounds
-Overall dimensions	15 1/2" high, 15 1/4" wide, 13 1/8" deep
-Cube	2.32
-Carton size	17 1/2" high x 17 1/2" wide x 13 1/2" deep

Sectionizer #	Style	Description	Sectionizer #	Style	Description
S-101	 4-Wedge	4 evenly spaced & cut wedges	S-106	 Apple	6 evenly spaced & cut wedges with center core removed
S-102	 6-Wedge	6 evenly spaced & cut wedges	S-112	 Apple	8 evenly spaced & cut wedges with center core removed
S-103	 6-Slice	6 slices (5/16" thick)	S-109	 Tomato	7 slices (1/4" thick) serrated
S-104	 8-Wedge	8 evenly spaced & cut wedges	S-110	 10-Wedge	10 evenly spaced & cut wedges
S-105	 3-in-1	2 halves scored in 3 wedges each			
S-107	 Single	Cuts fruit & vegetables in half			