



Quality products. Built to last.

pro series sectionizer



10 matching blade and plunger sets



Single



4-Wedge



6-Wedge



6-Wedge
Apple Corer



3-in-1



8-Wedge



8-wedge
Apple Corer





10-Wedge



6-Slice
(5/16")



Tomato 7-Slice
(1/4")

- ✓ Versatile, 10 different Interchangeable blade cups available
- ✓ Uniform pieces for appealing presentation
- ✓ Quick & easy cleanup – dishwasher safe
- ✓ Crafted in the USA  

SUNKIST
 Tel:800.383.7141 Fax:909.822.2125
 10730 Bell Court
 Rancho Cucamonga, CA 91730
www.sunkistequipment.com

Sunkist

Pro Series Sectionizer Information

Effective: November 1, 2017





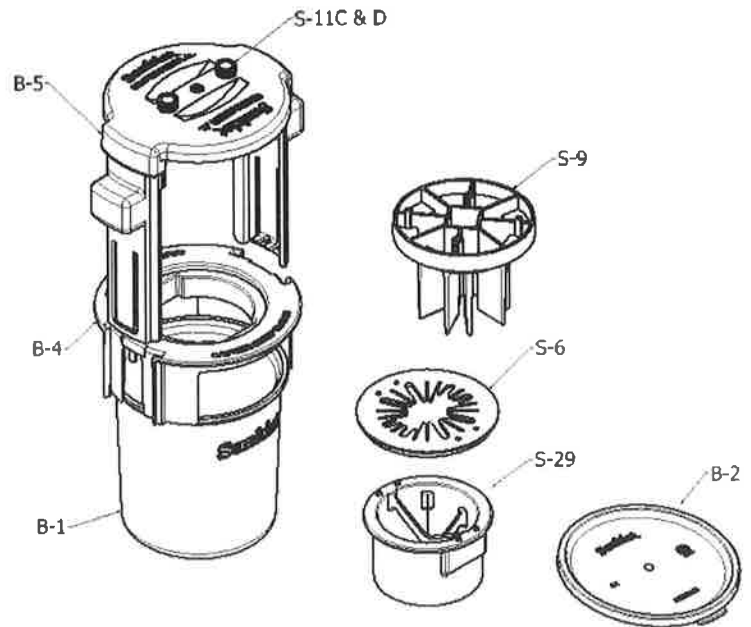





Part # Description

- B-1 Container – 2.7 Quart
- B-2 Lid – 2.7 Quart
- B-3 Container & Lid Assembly – 2.7 Quart
- S-3B Blade Cup w/cover (6 wedge) (fits S-9)
- S-4B Blade Cup w/cover (6 slice) (fits S-10)
- B-5 Plunger Assembly
- S-5B Blade Cup w/cover (4 wedge) (fits S-9)
- S-6 Wedger Cup cover (sold w/S-3, S-5, S-29, S-30, S-32, S-35)
- S-7 Slicer Cup cover (sold w/S-4)
- S-9 Plunger Wedger (fits parts S-3, S-5, S-29, S-30, S-35)
- S-10 Plunger Slicer (fits S-4)
- S-11C Brass Knob
- S-11D Brass Stud
- S-15B Blade Cup w/cover (7 Slice Tomato) (fits S-16)
- S-16 Plunger (7 Slice Tomato) (fits S-15)
- S-17K 7 Slice Tomato Set (S-15 & S-16)
- S-19 Wedger Cup Cover (10 Wedge) (sold w/S-20)
- S-20B Blade Cup w/cover (10 Wedge) (fits S-21)
- S-21 Plunger (10 Wedge) (fits S-20)
- S-22K 10 Wedge Set (S-20 & S-21)
- S-29B Blade Cup w/cover (8 Wedge) (fits S-9)
- S-30B Blade Cup w/cover (3-in-1) (fits S-9)
- S-31 Plastic Production Stand
- S-32B Blade Cup w/cover (Apple Corer-6 Wedge) (fits S-33)
- S-33 Plunger (Apple 6-Wedge & 8-Wedge) (fits S-32)
- S-34K Apple Corer-6 Wedge Set (S-32 & S-33)
- S-35B Blade Cup w/cover (Single) (fits S-9)
- S-37B Blade Cup w/cover (Apple Corer-8 Wedge) (fits S-33)
- S-33 Plunger (Apple 6-Wedge & 8-Wedge) (fits S-37B)
- S-38K Apple Corer-8 Wedge Set (S-37B & S-33)



Specifications

- Listed by.....NSF International
- Shipping weight.....5 pounds
- Net weight.....4 pounds
- Overall dimensions.....9 1/2" high, 9 1/2" wide, 7 5/8" deep
- Cube.....0.47
- Carton size.....10" high x 10" wide x 8" deep

Sectionizer #	Style	Description	Sectionizer #	Style	Description
B-201	 4-Wedge	4 evenly spaced & cut wedges	B-206	 Apple	6 evenly spaced & cut wedges with center core removed
B-202	 6-Wedge	6 evenly spaced & cut wedges	B-212	 Apple	8 evenly spaced & cut wedges with center core removed
B-203	 6-Slice	6 slices (5/16" thick)	B-209	 Tomato	7 slices (1/4" thick) serrated
B-204	 8-Wedge	8 evenly spaced & cut wedges	B-210	 10-Wedge	10 evenly spaced & cut wedges
B-205	 3-in-1	2 halves scored in 3 wedges each			
B-207	 Single	Cuts fruit & vegetables in half			